

Outline

- Definition
- Types
- Uses
- History
- Key components
- Applications
- Future
- Robotics @ MPCRL



Robot Defined

- Word robot was coined by a Czech novelist Karel Capek in a 1920 play titled Rassum's Universal Robots (RUR)
- Robot in Czech is a word for worker or servant



Karel Capek

● Definition of robot:

–Any machine made by by one our members: Robot Institute of America 😊

–A robot is a reprogrammable, multifunctional manipulator designed to move material, parts, tools or specialized devices through variable programmed motions for the performance of a variety of tasks: Robot Institute of America, 1979

Types of Robots: I

Manipulator



Types of Robots: II

Legged Robot

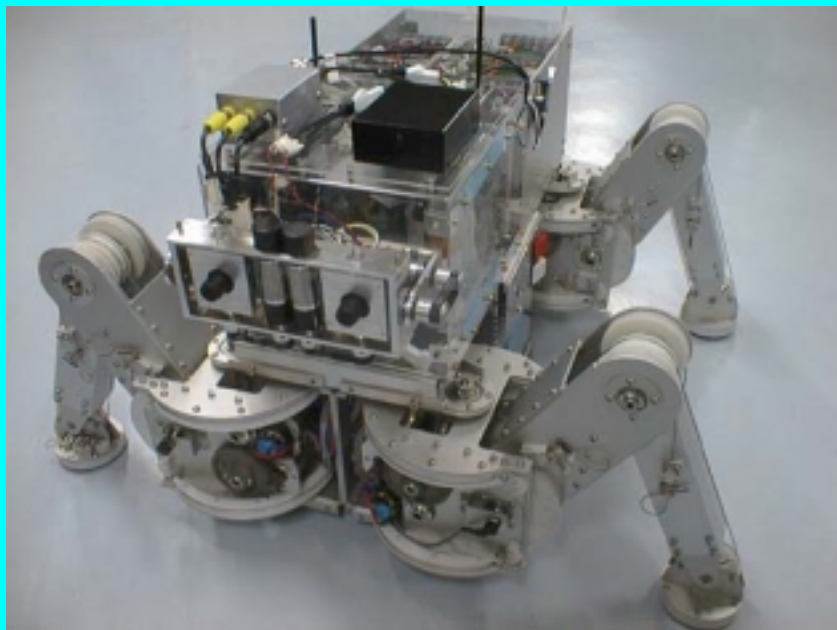

Wheeled Robot

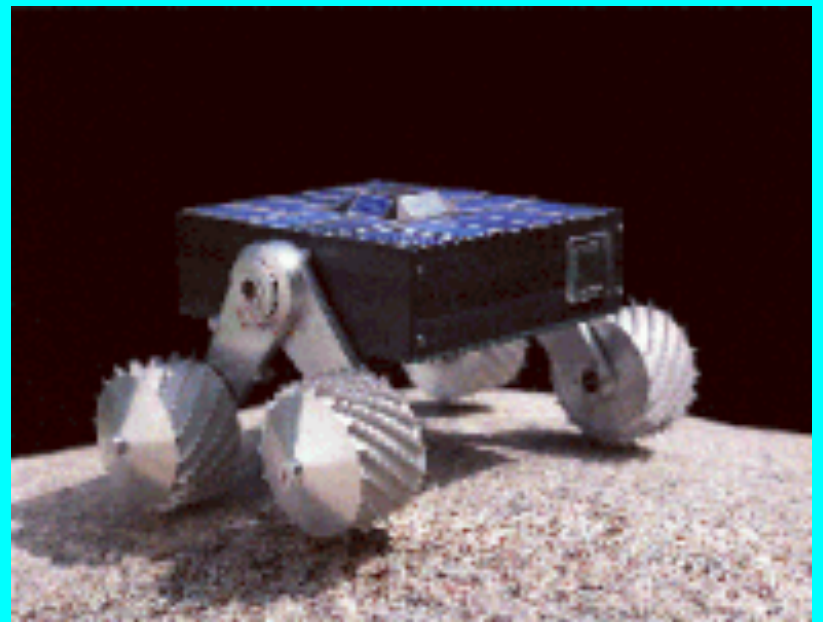

Types of Robots: III

Autonomous Underwater Vehicle



Unmanned Aerial Vehicle



Robot Uses: I



Jobs that are dangerous
for humans

Decontaminating Robot

Cleaning the main circulating pump housing in the nuclear power plant

Robot Uses: II



Welding Robot

Repetitive jobs that are boring, stressful, or labor-intensive for humans

Robot Uses: III



Menial tasks that human don't want to do

The SCRUBMATE Robot

Laws of Robotics

- Asimov proposed three “Laws of Robotics” and later added the “zeroth law”
- Law 0: A robot may not injure humanity or through inaction, allow humanity to come to harm
- Law 1: A robot may not injure a human being or through inaction, allow a human being to come to harm, unless this would violate a higher order law
- Law 2: A robot must obey orders given to it by human beings, except where such orders would conflict with a higher order law
- Law 3: A robot must protect its own existence as long as such protection does not conflict with a higher order law

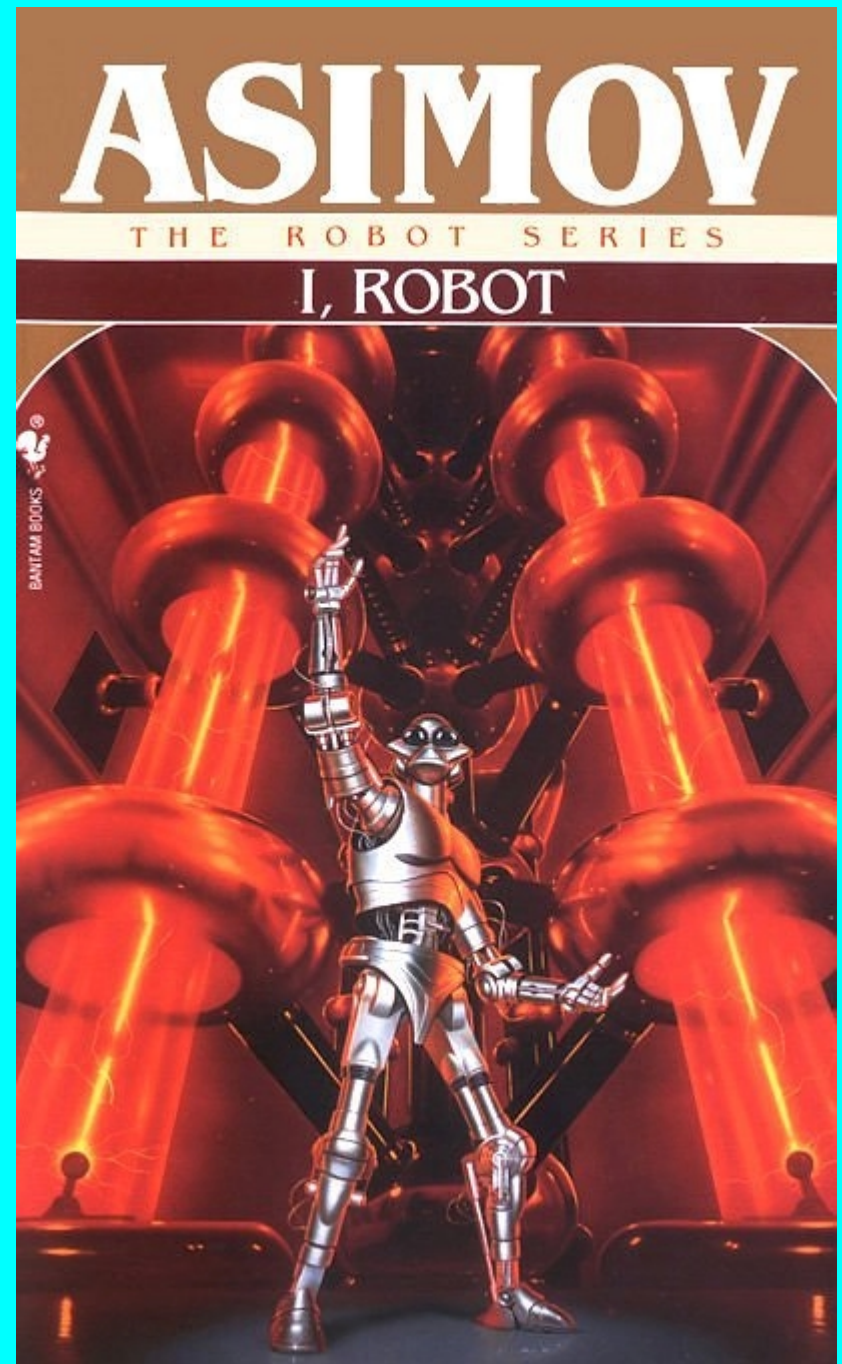

History of Robotics: I

- **The first industrial robot: UNIMATE**
- 1954: The first programmable robot is designed by George Devol, who coins the term Universal Automation. He later shortens this to Unimation, which becomes the name of the first robot company (1962).

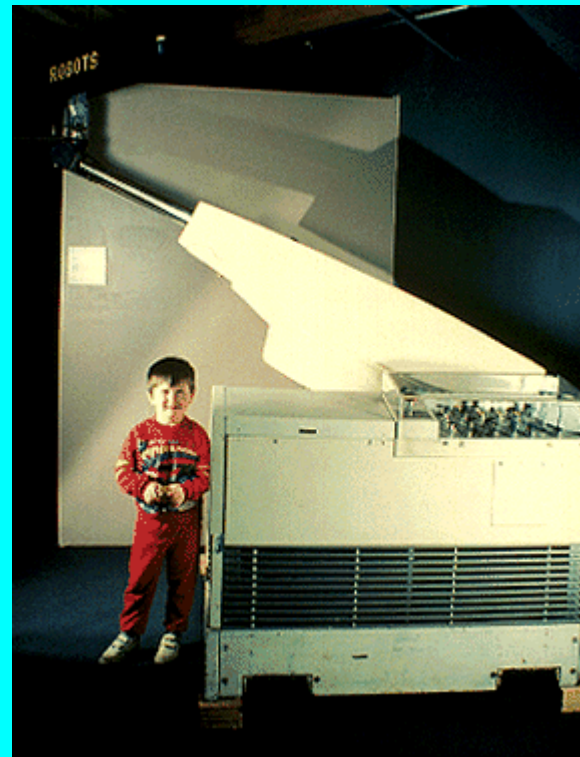

UNIMATE originally automated the manufacture of TV picture tubes

History of Robotics: II

1978: The Puma (Programmable Universal Machine for Assembly) robot is developed by Unimation with a General Motors design support

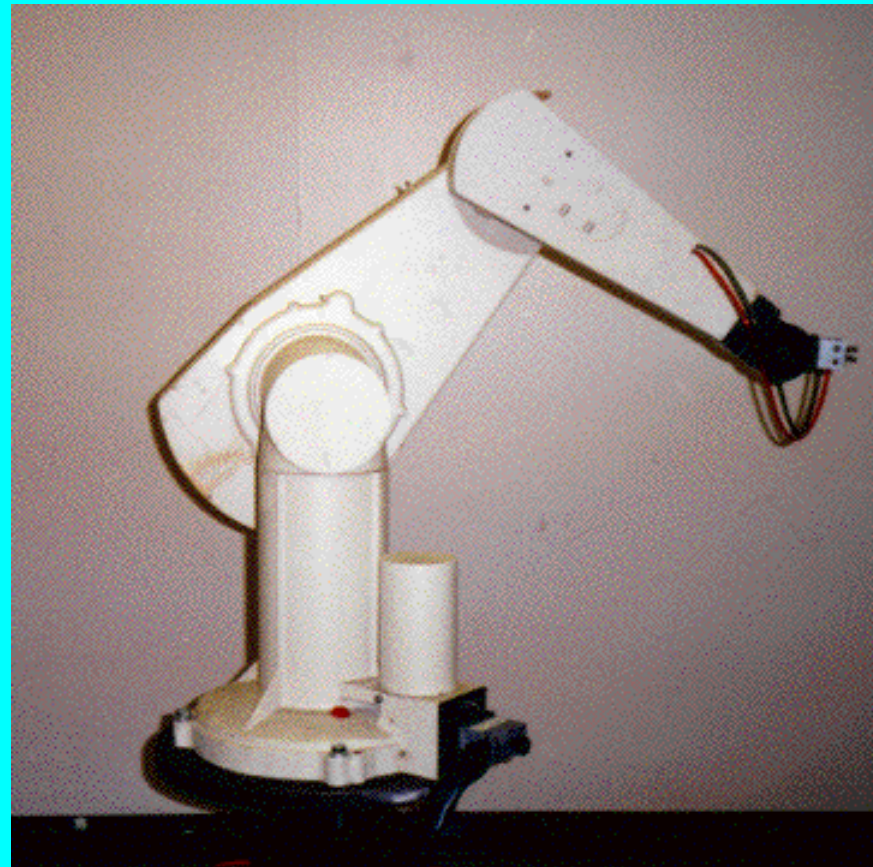

PUMA 560 Manipulator

History of Robotics: III

1980s: The robot industry enters a phase of rapid growth. Many institutions introduce programs and courses in robotics. Robotics courses are spread across mechanical engineering, electrical engineering, and computer science departments.



Adept's SCARA robots



Cognex In-Sight Robot



Barrett Technology Manipulator

History of Robotics: IV



1995-present: Emerging applications in small robotics and mobile robots drive a second growth of start-up companies and research

2003: NASA's Mars Exploration Rovers will launch toward Mars in search of answers about the history of water on Mars

Knowledgebase for Robotics

- Typical knowledgebase for the design and operation of robotics systems
 - Dynamic system modeling and analysis
 - Feedback control
 - Sensors and signal conditioning
 - Actuators (muscles) and power electronics
 - Hardware/computer interfacing
 - Computer programming

Disciplines: mathematics, physics, biology, mechanical engineering, electrical engineering, computer engineering, and computer science

Key Components

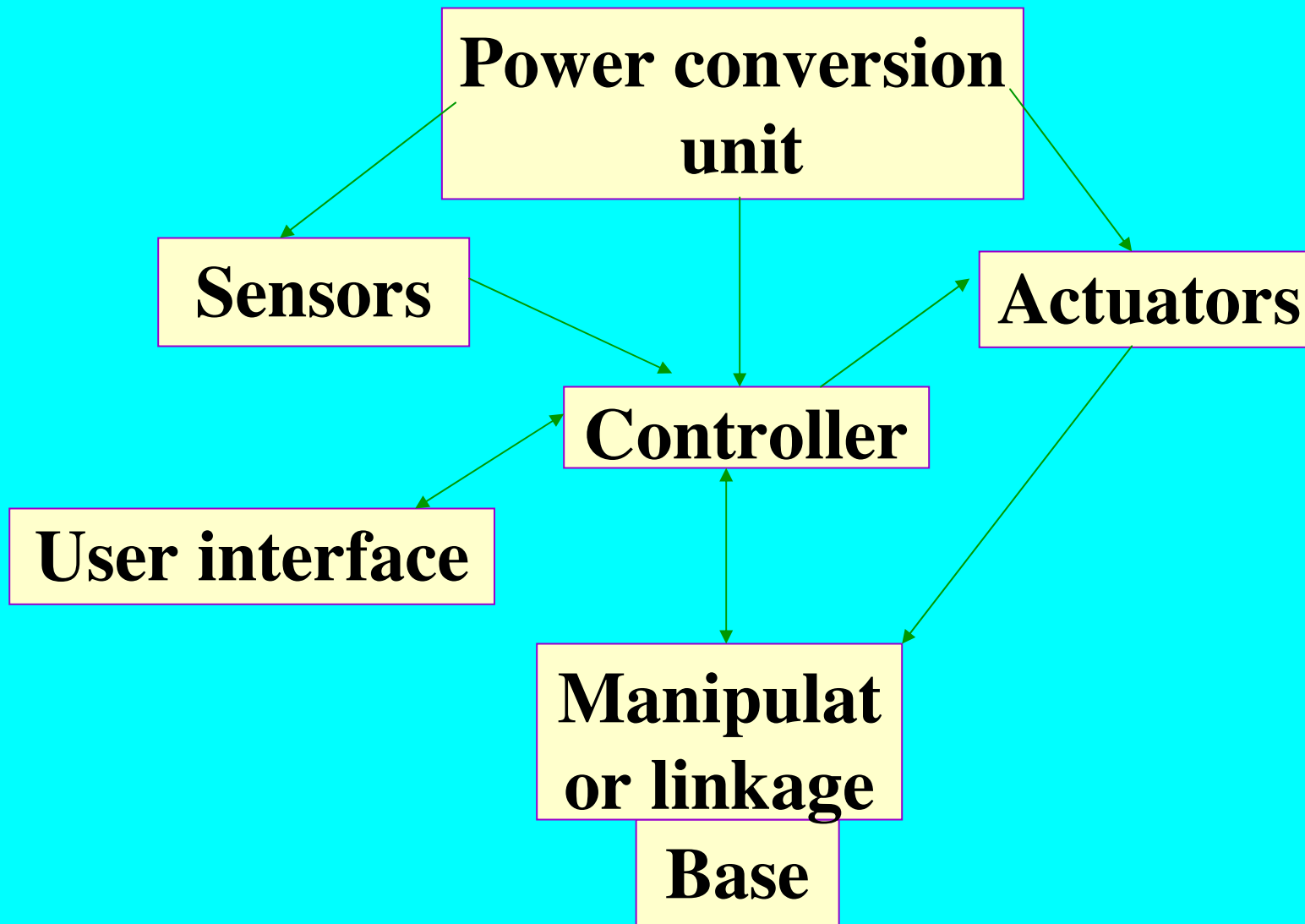

Robot Base: Fixed v/s Mobile

Robotic manipulators used in manufacturing are examples of fixed robots. They can not move their base away from the work being done.



Mobile bases are typically platforms with wheels or tracks attached. Instead of wheels or tracks, some robots employ legs in order to move about.

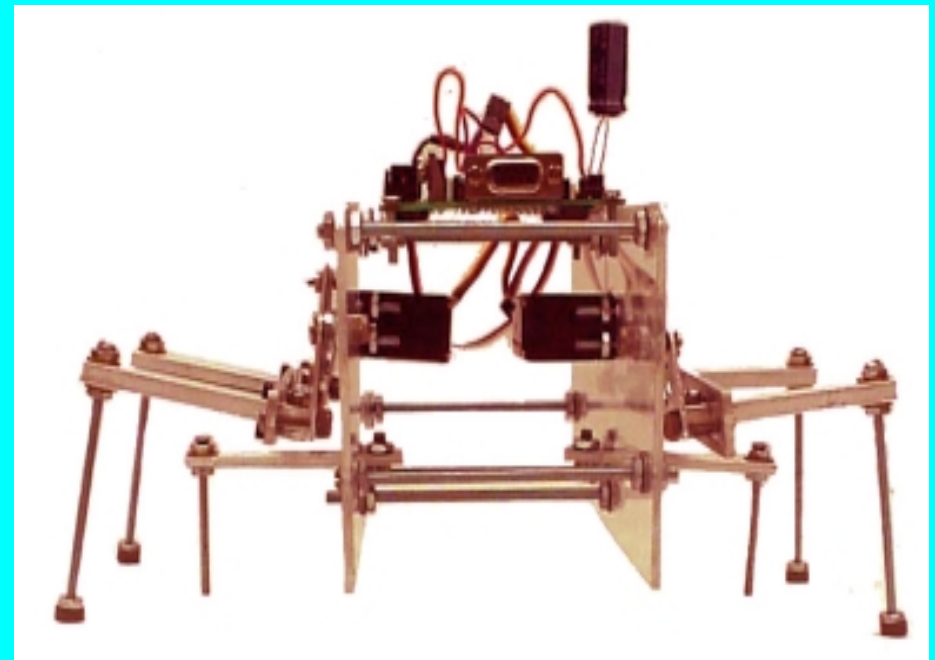

Robot Mechanism

Mechanical Elements



Sensors

- Human senses: sight, sound, touch, taste, and smell provide us vital information to function and survive
- Robot sensors: measure robot configuration/condition and its environment and send such information to robot controller as electronic signals (e.g., arm position, presence of toxic gas)
- Robots often need information that is beyond 5 human senses (e.g., ability to: see in the dark, detect tiny amounts of invisible radiation, measure movement that is too small or fast for the human eye to see)



Accelerometer
Using Piezoelectric Effect



Flexiforce Sensor

Vision Sensors

Vision Sensor: e.g., to pick bins, perform inspection, etc.

Part-Picking: Robot can handle work pieces that are randomly piled by using 3-D vision sensor. Since alignment operation, a special parts feeder, and an alignment pallette are not required, an automatic system can be constructed at low cost.



In-Sight Vision Sensors

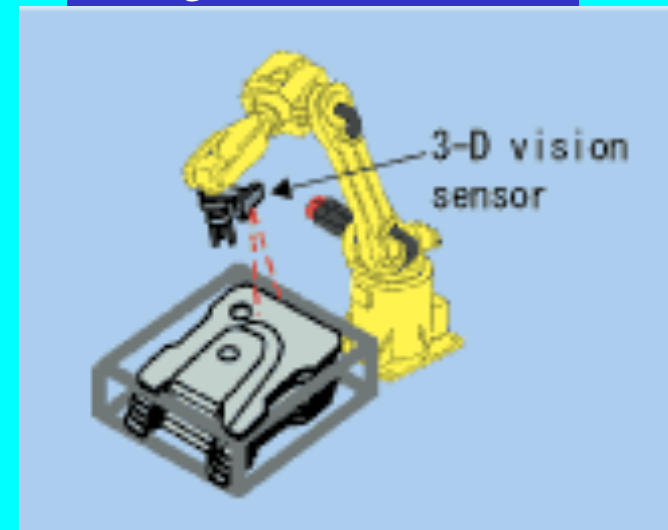

Force Sensors

Force Sensor: e.g., parts fitting and insertion, force feedback in robotic surgery

Parts fitting and insertion: Robots can do precise fitting and insertion of machine parts by using force sensor. A robot can insert parts that have the phases after matching their phases in addition to simply inserting them. It can automate high-skill jobs.

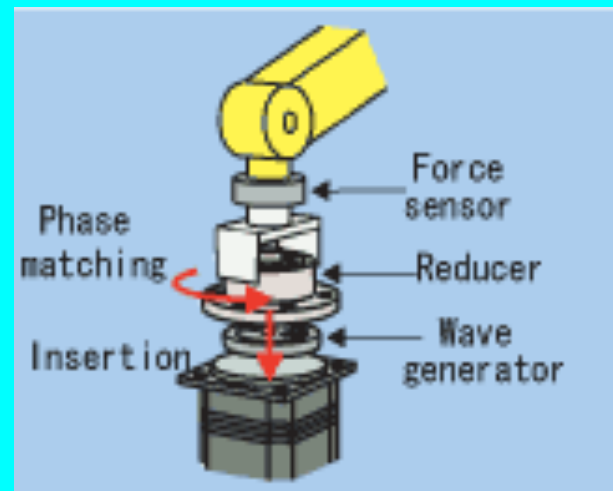
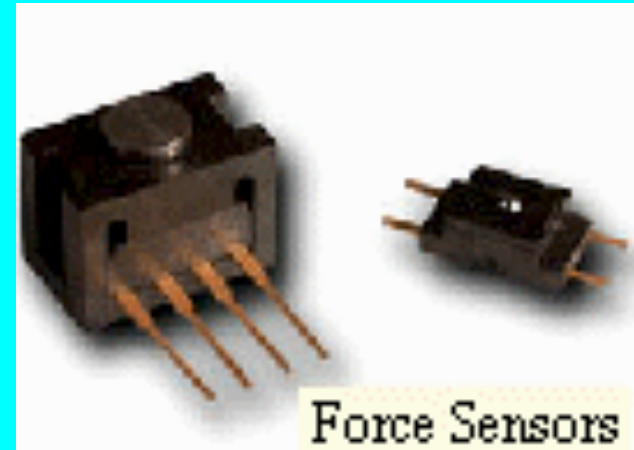

Proximity Sensors

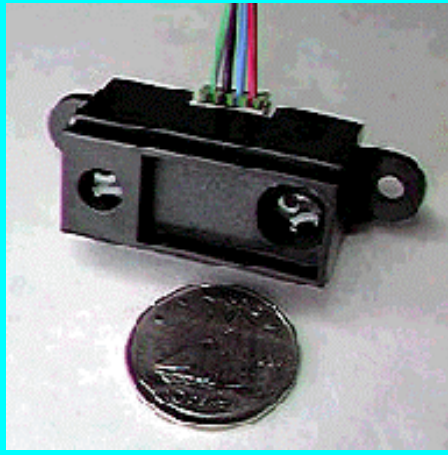

Infrared Ranging Sensor

Devantech SRF04

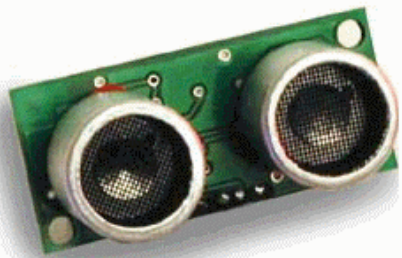

UltraSonic Ranger

Example



KOALA ROBOT

- 6 ultrasonic sonar transducers to explore wide, open areas
- Obstacle detection over a wide range from 15cm to 3m
- 16 built-in infrared proximity sensors (range 5-20cm)
- Infrared sensors act as a “virtual bumper” and allow for negotiating tight spaces

Tilt Sensors

Tilt sensors: e.g., to balance a robot



Tilt Sensor

Example

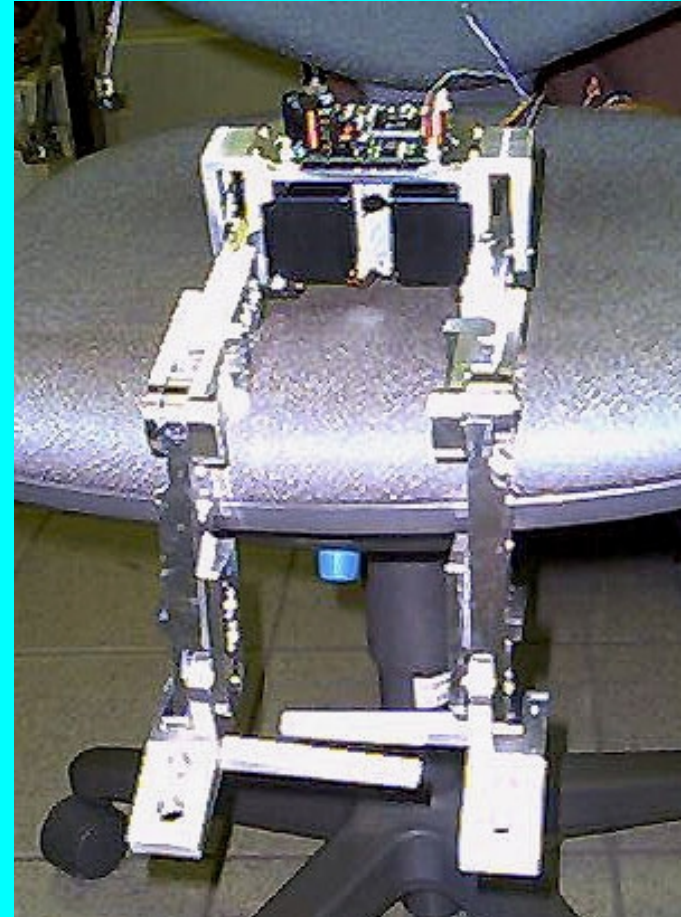

Planar Bipedal Robot

Actuators/Muscles: I

- Common robotic actuators utilize combinations of different electro-mechanical devices
 - Synchronous motor
 - Stepper motor
 - AC servo motor
 - Brushless DC servo motor
 - Brushed DC servo motor

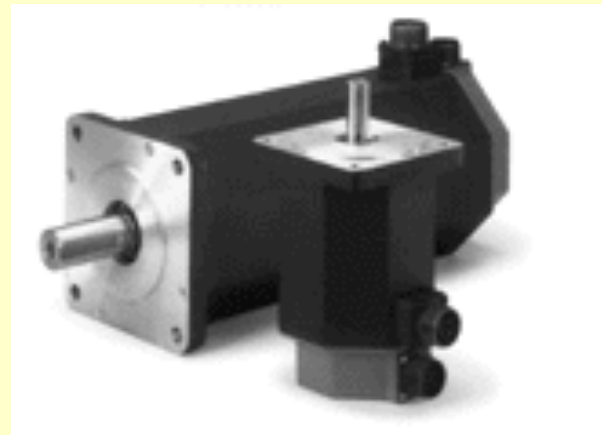

Actuators/Muscles: II



Hydraulic Motor



Pneumatic Cylinder



DC Motor



Stepper Motor

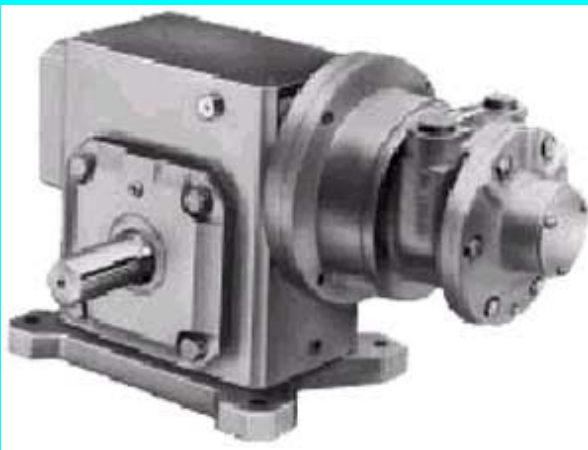

Pneumatic Motor

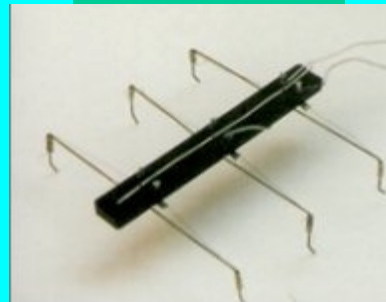

Muscle Wire



Servo Motor

Controller

- Provide necessary intelligence to control the manipulator/mobile robot
- Process the sensory information and compute the control commands for the actuators to carry out specified tasks

Storage Hardware

Storage devices: e.g., memory to store the control program and the state of the robot system obtained from the sensors

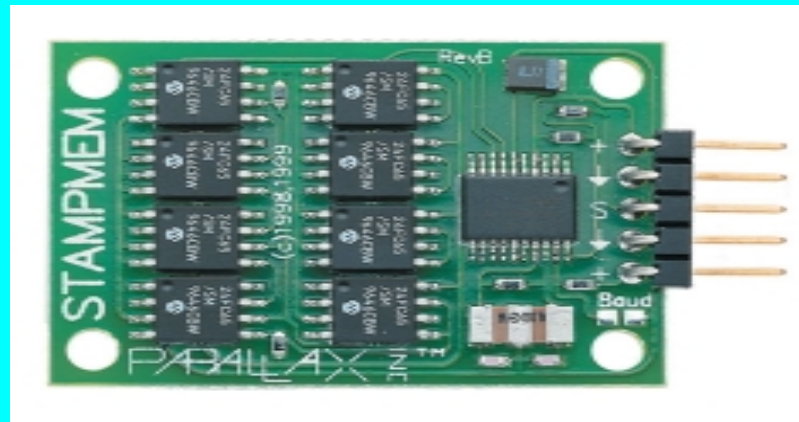

Computation Hardware

Computational engine that computes the control commands

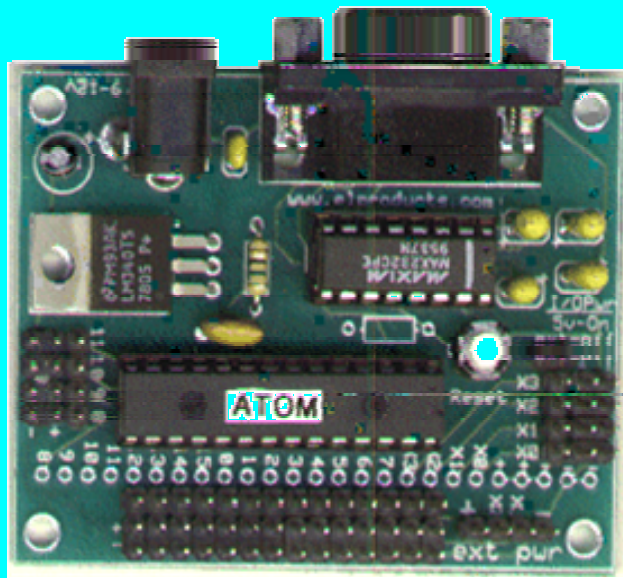

RoboBoard Robotics Controller

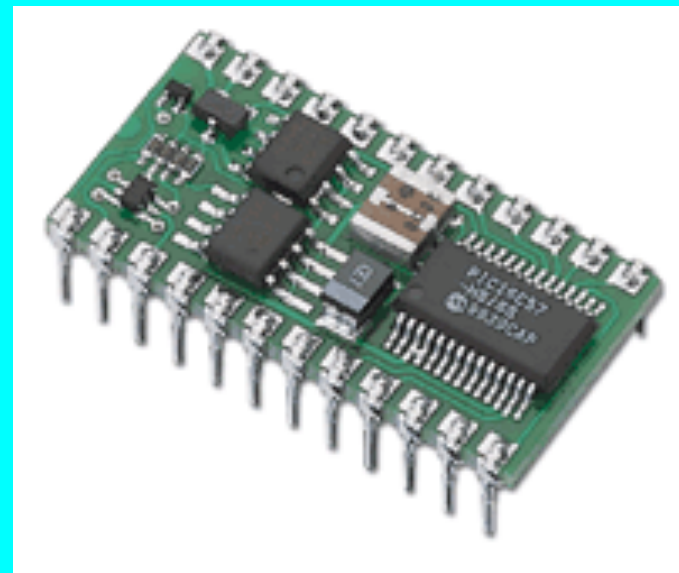

BASIC Stamp 2 Module

Interface Hardware

Interface units: Hardware to interface digital controller with the external world (sensors and actuators)

Analog to Digital Converter



Operational Amplifiers



LM358

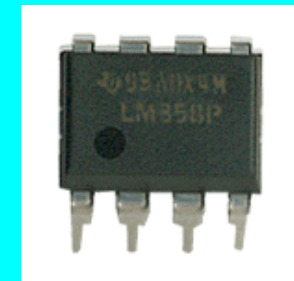

LM358

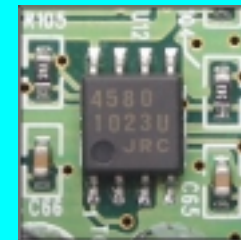

LM1458 dual operational amplifier

Robots in Industry

- Agriculture
- Automobile
- Construction
- Entertainment
- Health care: hospitals, patient-care, surgery , research, etc.
- Laboratories: science, engineering , etc.
- Law enforcement: surveillance, patrol, etc.
- Manufacturing
- Military: demining, surveillance, attack, etc.
- Mining, excavation, and exploration
- Transportation: air, ground, rail, space, etc.
- Utilities: gas, water, and electric
- Warehouses

Industrial Applications of Robots

- Material handling
- Material transfer
- Machine loading and/or unloading
- Spot welding
- Continuous arc welding
- Spray coating
- Assembly
- Inspection



Material Handling Manipulator

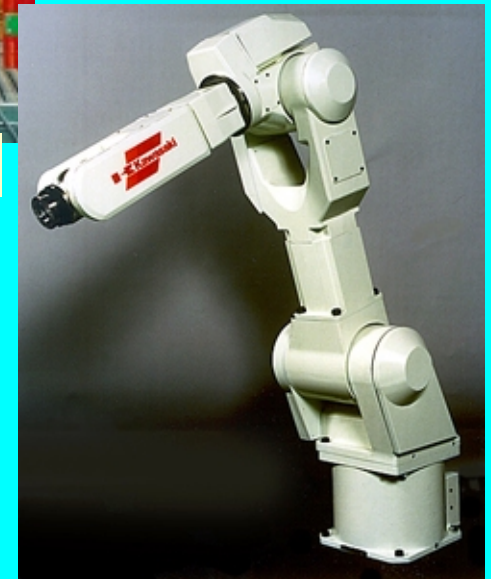

Assembly Manipulator

Robots in Space



NASA Space Station



Robots in Hazardous Environments



TROV in Antarctica
operating under water

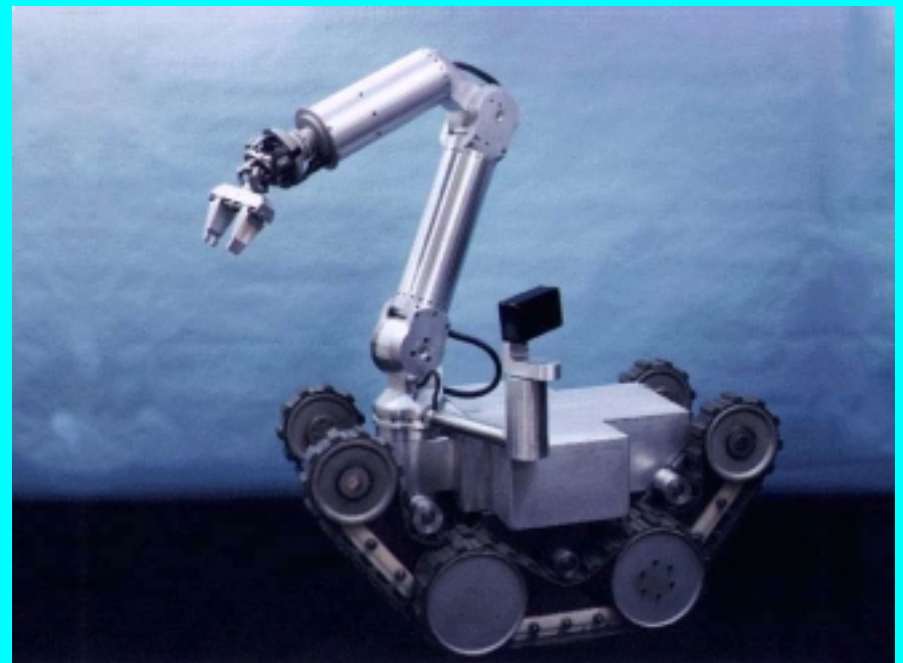

HAZBOT operating in
atmospheres containing
combustible gases

Medical Robots

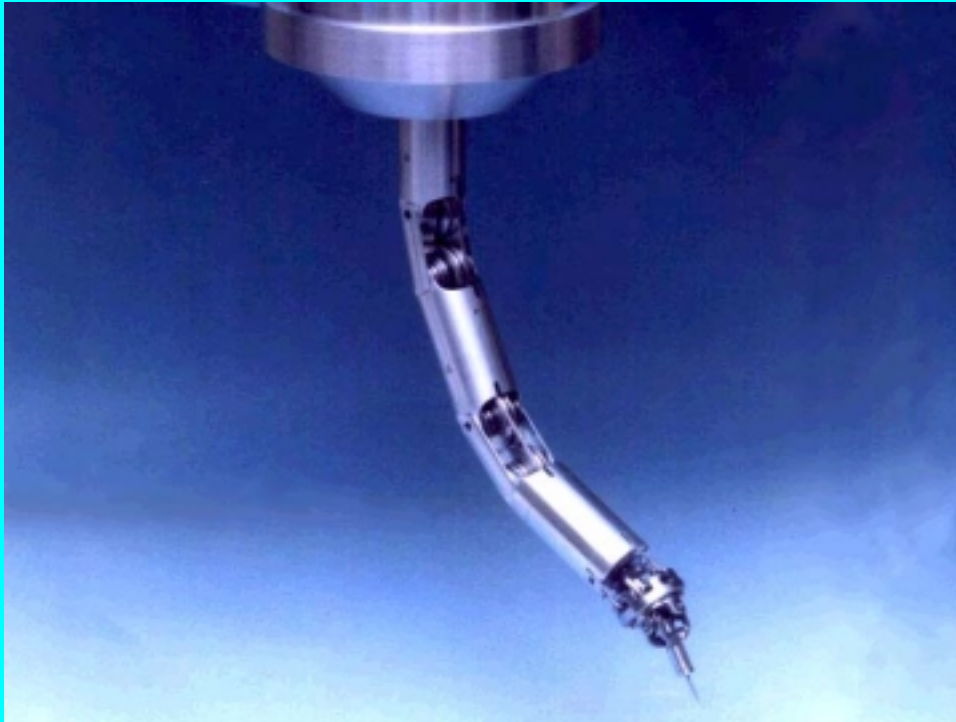

Robotic assistant for
micro surgery



Robots in Military

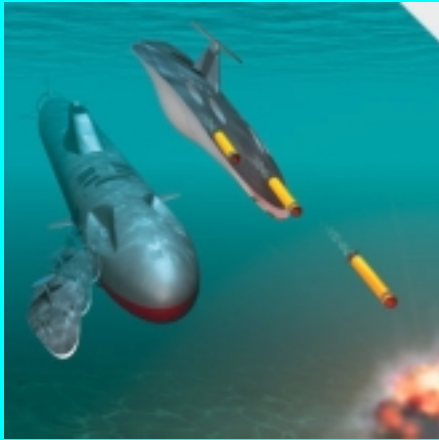

SPLIT STRIKE:
Deployed from a sub's hull, Manta could dispatch tiny mine-seeking AUVs or engage in more explosive combat.



PREDATOR



ISTAR



GLOBAL HAWK



GOLDENEYE

Robots at Home



Sony SDR-3X Entertainment Robot



Sony Aibo

Future of Robots: I

Artificial Intelligence



Cog



Kismet

Future of Robots: II

Autonomy



Robot Work Crews



Garbage Collection Cart

Future of Robots: III

Humanoids

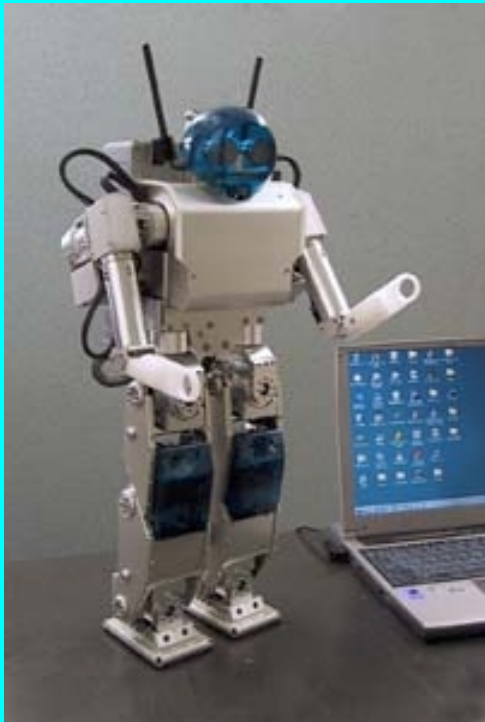

HONDA Humanoid Robot

Robotics @ MPCRL: Remote Robot Arm Manipulation

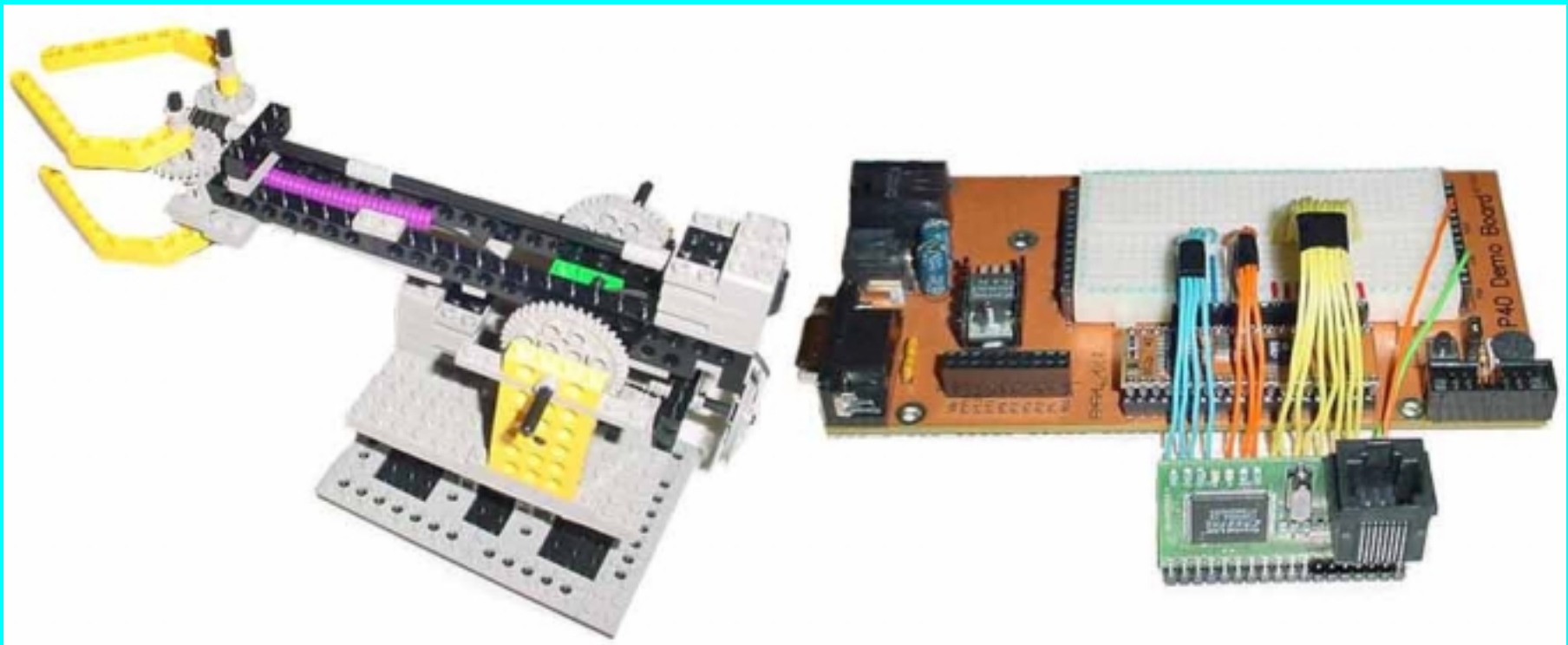

Robotics @ MPCRL: Smart Irrigation System

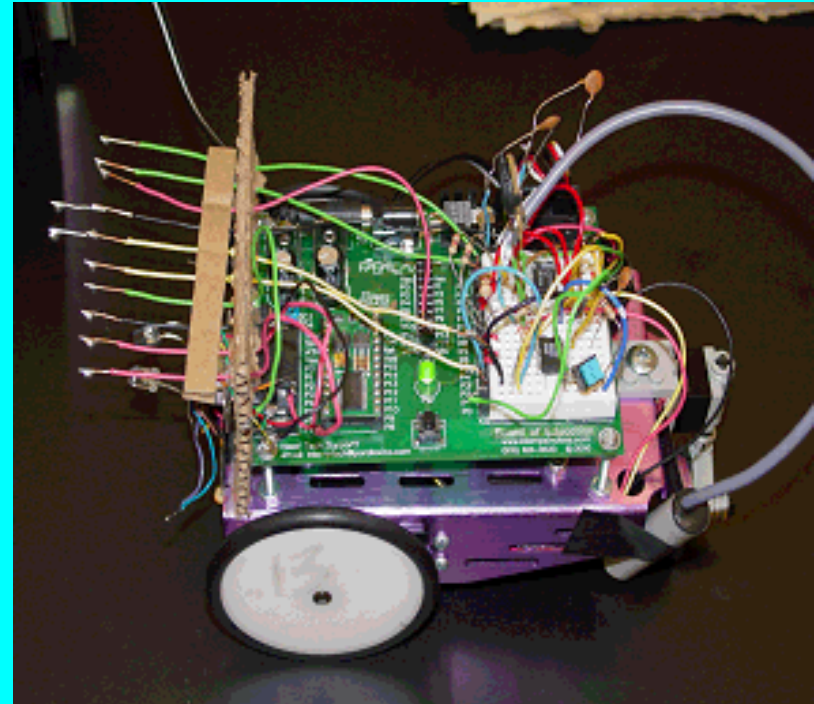
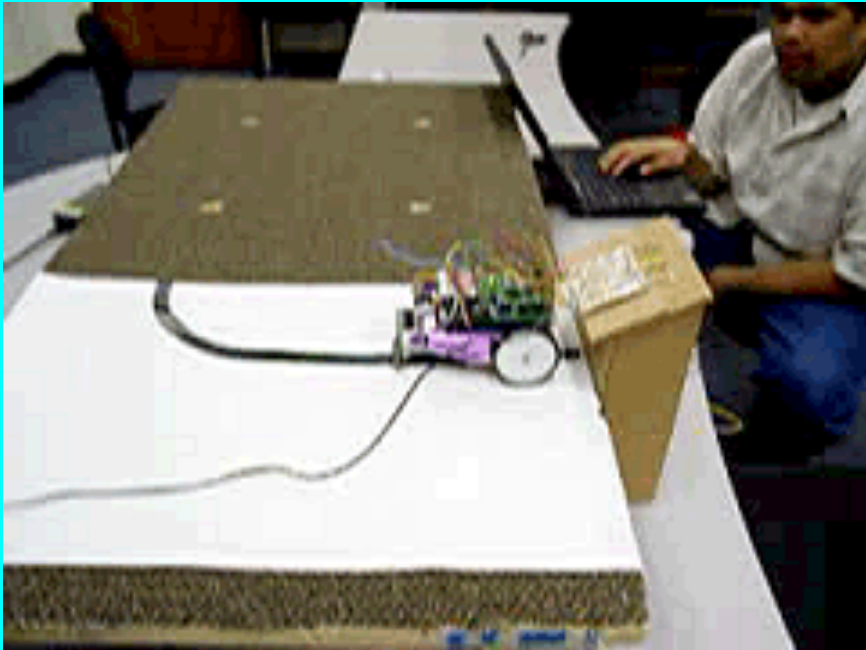

Robotics @ MPCRL: RoboDry

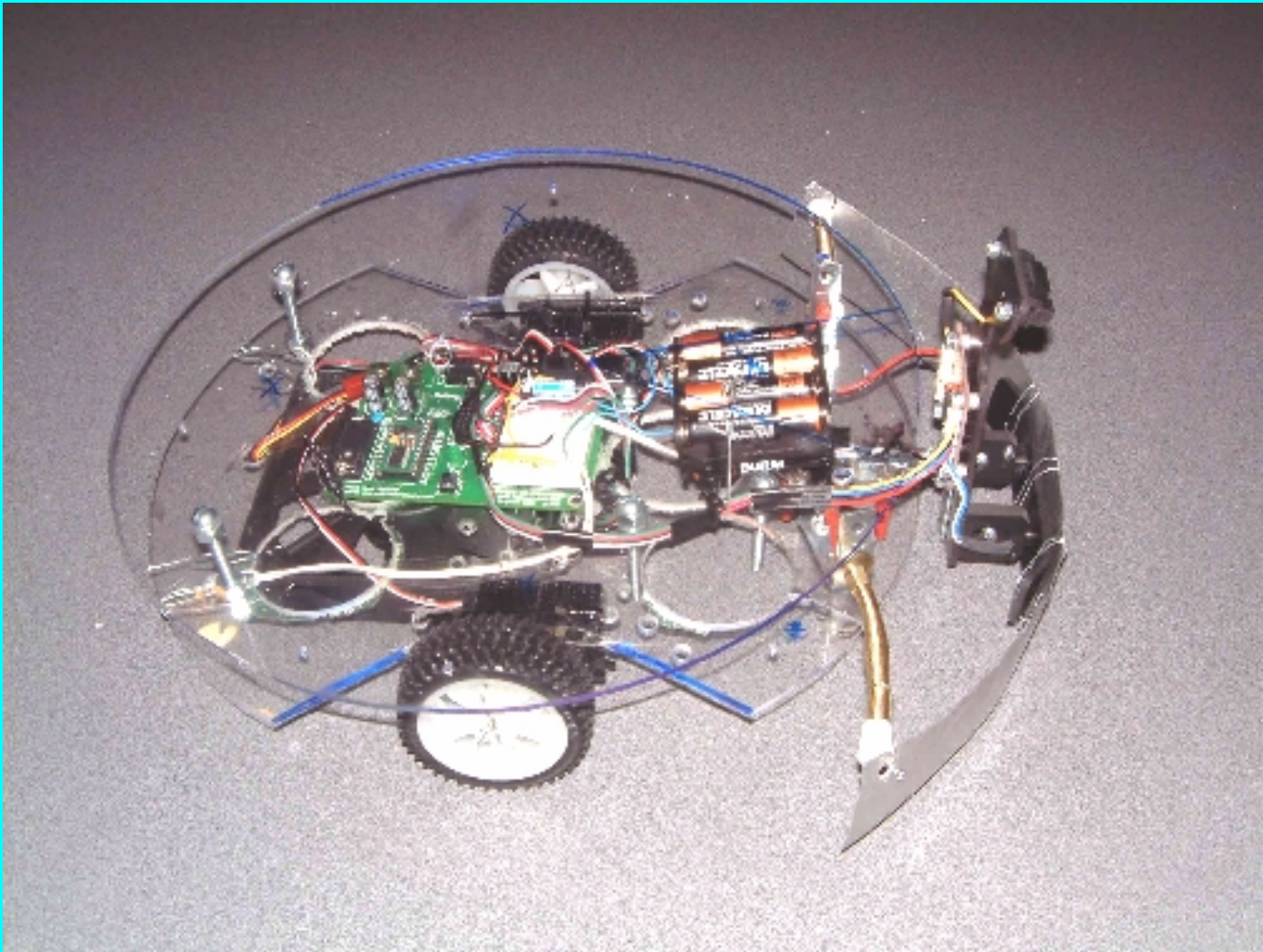

Robotics @ MPCRL: 4-Legged Hexapod

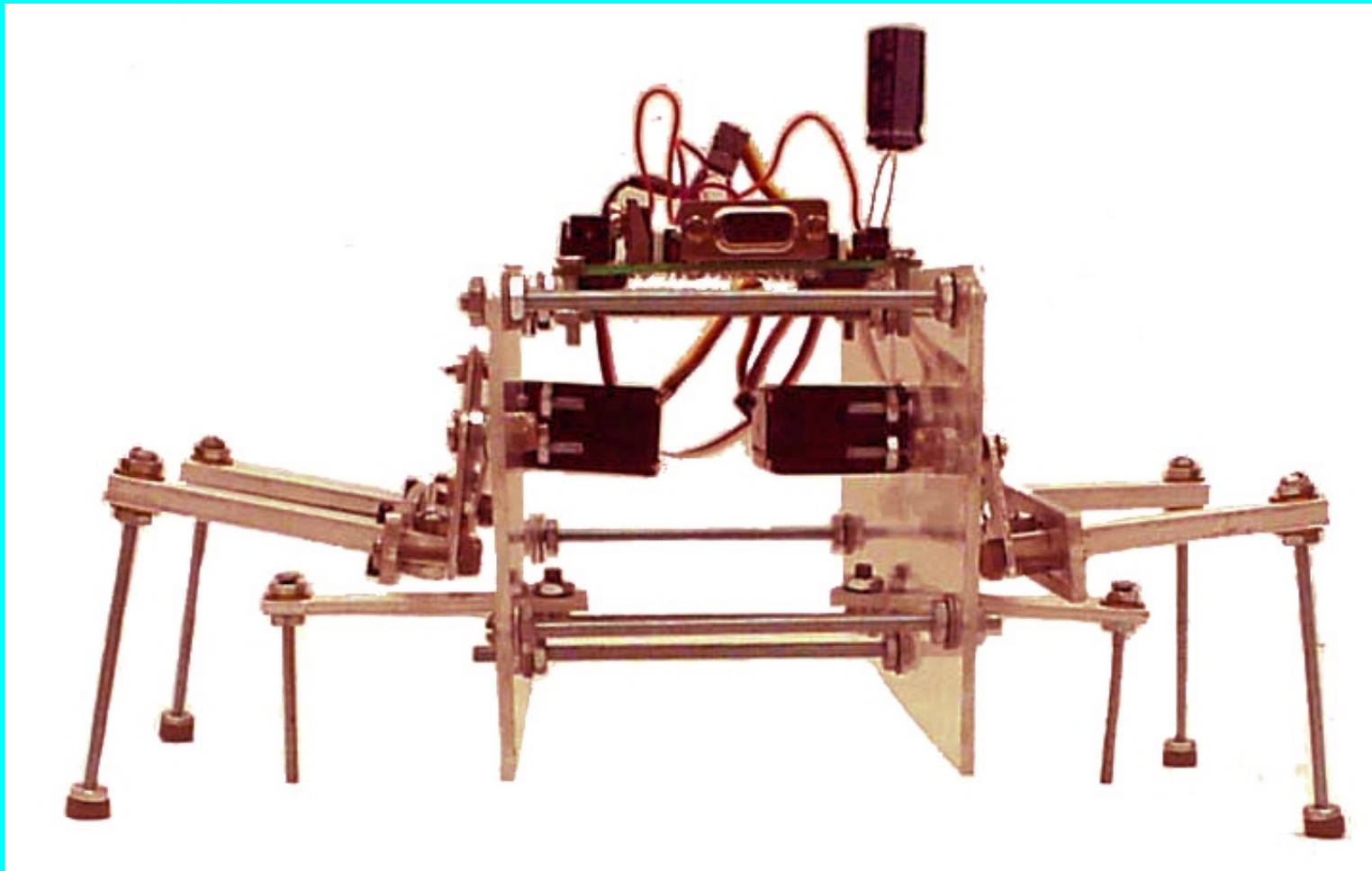

Robotics @ MPCRL: Hexapod for Disaster Recovery

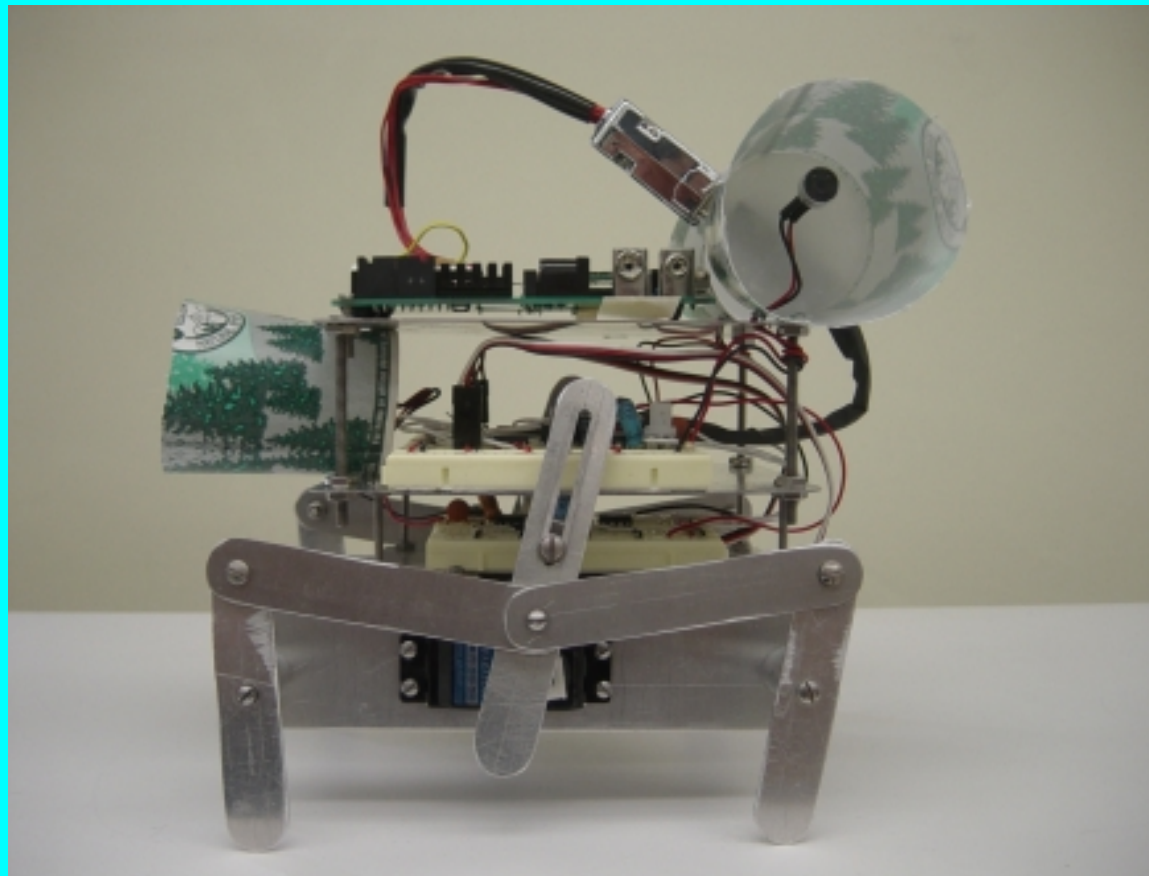

Robotics @ MPCRL: Hexapod for Disaster Recovery

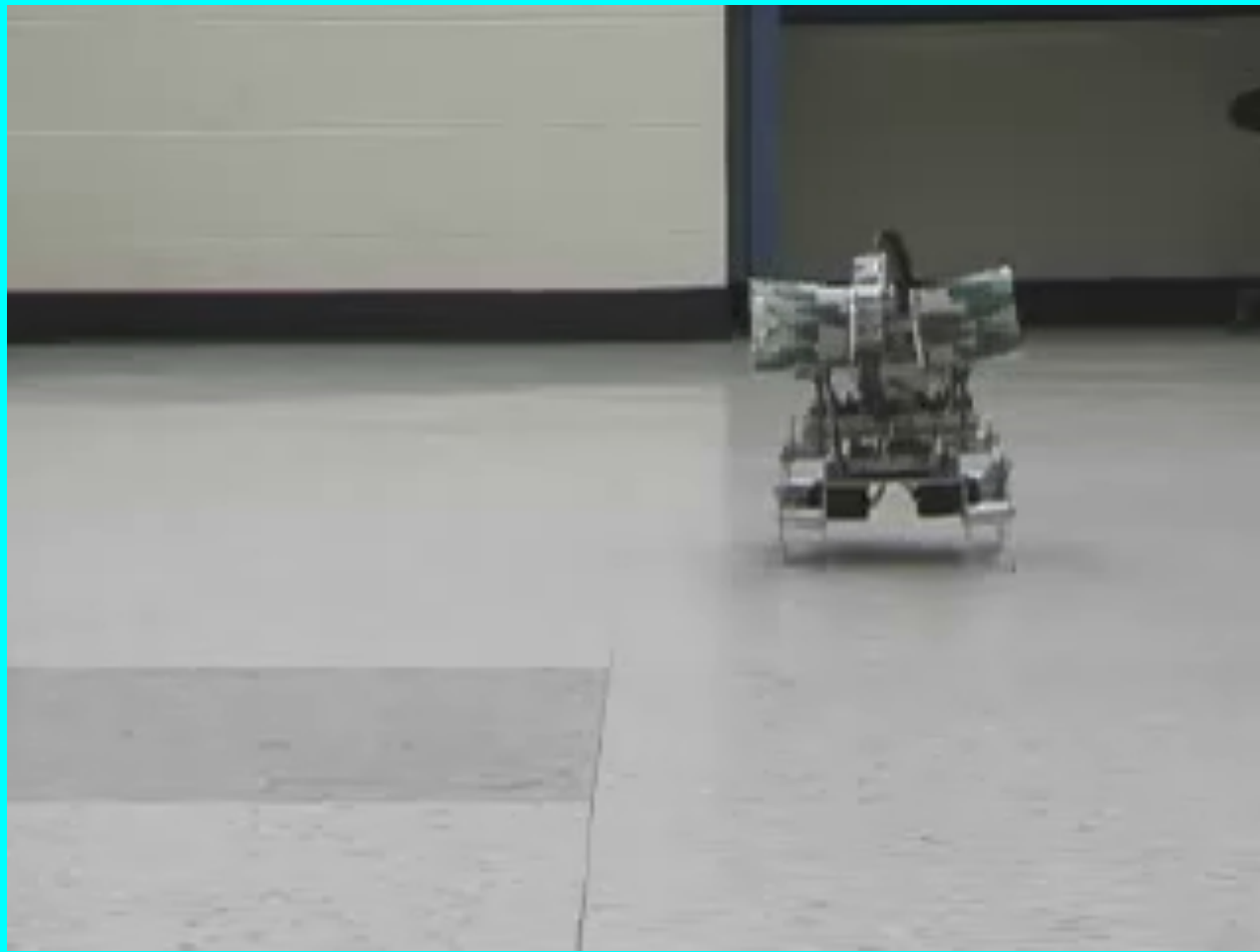

Robotics @ MPCRL: Robotic Vacuum Cleaner



Robotics @ MPCRL: Automated Distinguisher

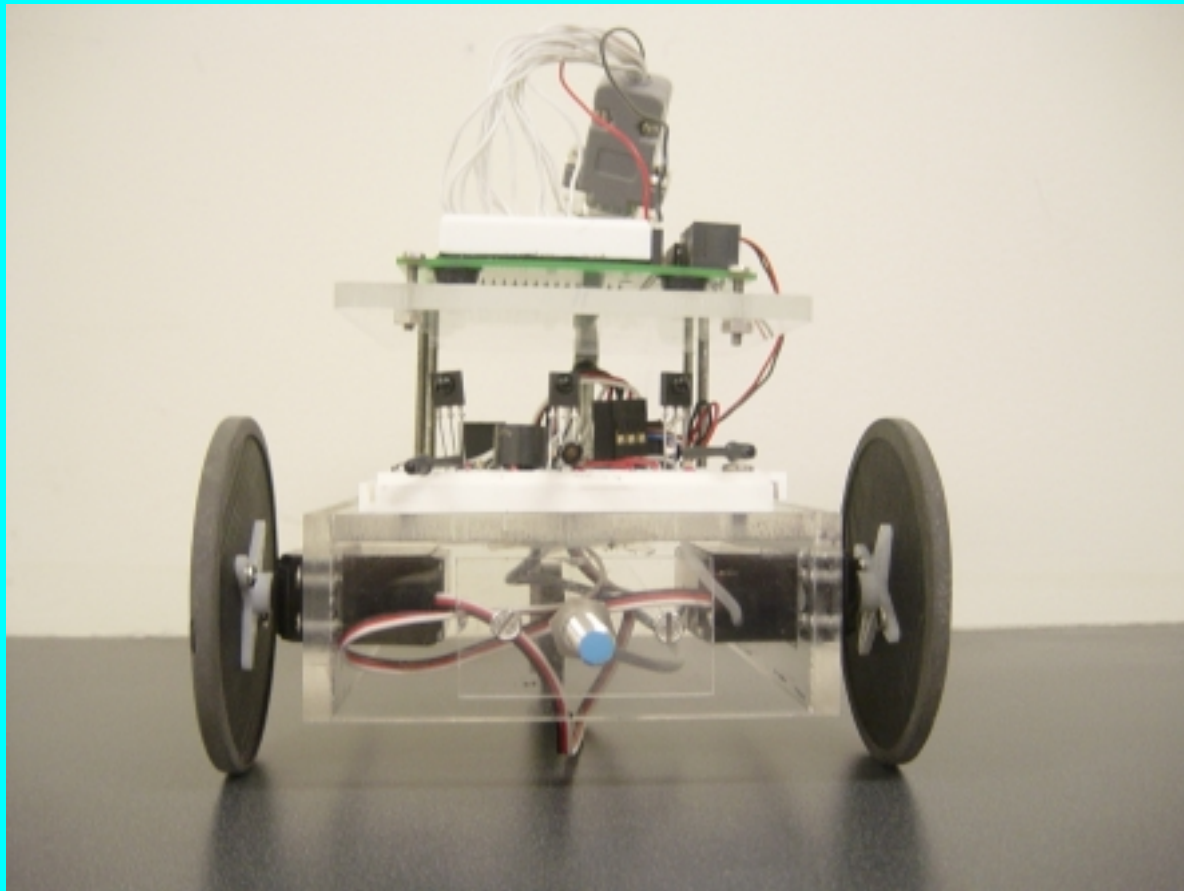

Robotics @ MPCRL: Automated Distinguisher

